

RADIOPHYSICAL RESEARCH INSTITUTE,
GORKY, USSR

preprint N 24

A.F.Krupnov



НИИРФИ

MILLIMETER AND SUBMILLIMETER WAVE
WIDE -RANGE GAS RADIO SPECTROSCOPY

1972

Mastering of the millimeter and submillimeter wave ranges is one of the main trends in the development of the present radio spectroscopy. Here rotational lines have the highest intensity which exceeds by three-four orders of magnitude the intensity of lines in the centimeter range and the bandwidth increases almost by two orders of magnitude in comparison to the "classical" for the radio spectroscopy centimeter wave range. Moreover there are spectra in the submillimeter wave range which are absent in the more long-wave region. All these reasons make the transfer of the radio spectroscopic investigations in millimeter and submillimeter wave ranges highly attractive. Only technical possibilities are determinative in the development of this trend.

The present paper gives the results of work on the development of the radio spectroscopic methods in millimeter and submillimeter wave ranges carried out recently at the Radiophysical Research Institute (NIRFI) Gorky, USSR [I -10] .

I. Radio spectroscope with acoustic detector

We are developing the method of radio spectroscopy [7] based on the effect of gas sounding when absorbing the radiation which was discovered and investigated by Bell, Tyndall and Röntgen in 1880-1881 [11]. This method is widely used in the infrared gas analyzers [12] but in the radio spectroscopy it was completely left behind after a single experiment in 1946 [13]. However our investigations show that it has a number of valuable specific features allowed to obtain the highest absorption coefficient sensitivity in the submillimeter wave range ($2 \cdot 10^{-7} \text{ cm}^{-1}$) and easily carry out the automatic spectra recordings in the whole backward wave oscillator (BWO) tuning range (of the order of octave) without any kind of other microwave tunings (see Figs 1 and 2). The sensitivity of the submillimeter radio spectroscope with the acoustic detection appears higher than have the traditional radio spectroscopes with microwave reception. The radio spectroscope was tested at $2 + 0.5 \text{ mm}$ wave range [7].

Fig 3,4 shows the block-schemes of a traditional radio spectroscope with a microwave detector and a radio spectroscope with an acoustic detection. In the traditional radio spectroscope the radiation passes through

a gas cell and directs to the microwave detector. In the presence of the absorption line the input power of the microwave detector is

$$P = P_0 e^{-\gamma l} = P_0 - \gamma l P_0 \quad (\gamma l \ll 1),$$

where P_0 is the radiation source power, γ is the line absorption coefficient, l is the cell length.

In the radio spectroscope with the acoustic detector the radiation of the source also passes through the cell filled with the gas investigated but the receiver behind the cell is absent. The investigated gas itself serves here as a receiver. When the radiation frequency coincides with the frequency of the spectral line, the gas absorbs the power, heats and increases the pressure in the cell. This pressure represents the signal from the absorption line registered by the sensitive microphone placed in the cell. The magnitude of the signal from the line is defined by the power absorbed by the gas.

$$P = P_0 (1 - e^{-\gamma l}) = \gamma l P_0 \quad (\gamma l \ll 1) \quad (2)$$

Comparison of (1) and (2) shows the advantage of the acoustic detection method: outside the absorption lines the signal is absent and lines are registered from the "zero" level. The essential consequences of this are:

- a) The possibility of the effective increase of

the absorption coefficient sensitivity by increase of the radiation source power. Indeed, the growth of the radiation power does not cause (at least in principle) the increase of the receiver noise and the signal-to-noise ratio increases proportionally to the radiation power P_0 , i.e. the minimum detectable absorption coefficient is inversely proportional to P_0 :

$$\gamma_{\min} (\text{PAQ}) \sim \frac{1}{P_0} \quad (3)$$

In an ordinary radio spectroscope with microwave detector the presence of the power on the receiver (the first, noninformative term in (I)) produces the increase of noise and the sensitivity in the small power region increases only as

$$\gamma_{\min} (\text{CBQ}) \sim \frac{1}{\sqrt{P_0}} \quad (4)$$

and with the power level higher than a milliwatt sensitivity begins to decrease [16] . In the radio spectroscope with the acoustic detector we do not observe the increase of noise with the power level of about a watt. This change of the character of the absorption coefficient sensitivity dependence on the radiation

power permits to exceed the sensitivity of the radio spectroscopy with microwave detector ($10^{-9} + 10^{-10} \text{ cm}^{-1}$) using the radio spectroscopy with the acoustic detector [16]. Indeed, for the real values of parameters (with the radiation power P_0 in watts) the estimated sensitivity of the radio spectroscopy with the acoustic detector determined by the thermal noise of the gas is equal to

$$\delta_{\min} (\text{cm}^{-1}) = \frac{3 \cdot 10^{-11}}{P_0} \quad (5)$$

The real sensitivity obtained by us

$$\delta_{\min} (\text{cm}^{-1}) = \frac{2 \cdot 10^{-9}}{P_0} \quad (6)$$

The power limitation is due to the effect of the line saturation. Table I gives the allowed (nonsaturating) values of the power flux in wt/cm^2 for different values of the dipole moment and the spectral line width. It is essential that the allowed power increase as the square of the line width (and inversely proportional to the square of the dipole moment). At the common cross sections of the absorbing cell ($\sim 1 \text{ cm}^2$) these permissible powers exceed essentially those for the radio spectroscopy

with microwave reception; this provides the possibility of a rather considerable increase of the sensitivity.

b) The absence of the signal outside the spectral lines makes convenient the spectrum record by scanning the radiation source frequency. In this case lines are recorded at the "zero" level (see Figs I and 2). Submillimeter radiation sources (BWO [I4]) represents electrical diodes; their frequency is defined in fact by the one parameter - by the magnitude of applied high voltage. At the voltage change roughly from 1 to 4.5Kv the frequency of the BWO is tuned by nearly octave [I4]. The electronic control of the BWO frequency combined with the zero character of the acoustic radio spectroscopy makes possible obtaining for the first time the continuous records of a large parts of the submillimeter spectrum of the gases.

The continuous spectra records obtained in the frequency range of several hundreds gigahertz poses newly the problem of the transition identification and permits to choose a more interesting parts of the spectrum for the investigation (see Figs I and 2). The resolving power may be changed from 10^{-2} to $3 \cdot 10^{-5}$ (the last value is defined by the instabilities of the BWO frequency).

c) The fact that the signal in the cell is formed by the absorption of only a small part of the power and the larger part of the power passes through the cell makes possible as in the infrared acousto-optical gas analysers to place several cells at the beam way, i.e. to perform multichannel spectra records. One of the simultaneously recorded spectra may be used as a reference for the visual or automatic comparison with the investigated one.

d) The absence of disturbances from the interference due to the microwave tract and detector in the sub-millimeter wave range permits easy observations of wide (in our tests up to 600 MHz [7]) lines. We also observe line width of about 1 MHz. It allows to make convenient and exact measurements of the dependence of the spectral line broadening on the pressure, i.e. the so-called parameter of the line broadening.

The volume thermal character of the signal reception from the line ensures the independence of the sensitivity on the frequency and considerably decrease the interference effects. The sensitivity independence on the frequency makes possible to obtain the high "concentration" sensitivity in the region of millimeter

and submillimeter wave ranges where the absorption coefficients for the rotations lines are maximum [15].

Fig 5 shows the record of the transition $J = 13 \rightarrow 14$ at the wave length of about 0.88mm of the isotopic specie of nitrous oxide $N^{15}N^{14}O^{16}$ in the natural abundance ($3.6 \cdot 10^{-3}$) on which the vibrational satellite with the abundance nearly 20 times smaller is seen. To observe such lines in the wave range 1.2cm (25GHz,

$J = 0 \rightarrow 1$) one would require the sensitivity of $5 \cdot 10^{-11} \text{ cm}^{-1}$ which is unachievable now at the time constant equal to 1sec. Fig 6 illustrate the record of the water tra-

nsitions $I_{01} - I_{10}$ of H_2O^{16} and its isotopic species H_2O^{17} and H_2O^{18} in natural abundances ($4 \cdot 10^{-4}$ and $2 \cdot 10^{-3}$ respectively) at the wavelength of about 0.54 mm.

In Fig 6 the value of the signal-to-noise ratio for the main line exceeds 10^5 .

We carried out the analysis of the processes occurred in the cell with a microphone and determined the optimal parameters of the cell and the microphone. The equality of the gas and the membrane elasticity is the basic condition of the signal maximum.

$$\frac{\pi P_0 R^4}{8 V_s T^*} = 1 \quad (7)$$

and the condition of the modulation frequency ω is

$$\omega\tau \approx 1, \quad (8)$$

where p_0 is the pressure in the cell, V_0 is its volume, ρ is the radius of the membrane, T^* is the membrane tension in dyne/cm, τ is the time constant of the thermal processes in the cell. In our spectroscopy now condition (I) is not satisfied (the membrane is too hard) and the sensitivity loss is of about 60. The sensitivity of our spectroscopy is defined not by thermal gas noise but by the noise of the electron scheme. It also represents the sensitivity reserve.

Simplicity, wide range and high sensitivity of the radio spectroscopy with the acoustic detector allow the development on its basis a commercial device for the spectroscopic investigation of the submillimeter wave range. We are working in this direction. Fig.7 gives a general view of one of the variants of the submillimeter radio spectroscopy with the acoustic detector.

2. Frequency measurement in submillimeter wave range and the problem of computer spectra processing

The system of frequency measurement with the ac-

curacy of $2 \cdot 10^{-6}$ in the range up to 0.5 mm wavelength (600 GHz) was developed at NIRFI [6] and formaldehyde [6] and ammonia [2,4,9] spectra was investigated with its help. The general view of the submillimeter video radio spectroscope with the system of the frequency measurements is given in Fig.8. When the system of the frequency measurements operates with the radio spectroscope with the acoustic detector it is convenient to stabilize the frequency of the BWO over the measured line. The further refinement of the system is possible by way of substitution of the narrow-band klystrons with the mechanical tunings by wide-band backward wave oscillators with the electron tuning. Such substitution is possible on the base of the system of phase-locking of the BWO frequency in the range up to 0.8 mm wavelength [8], developed at NIRFI.

A maser radio spectroscope with the system of the precision frequency measurement (with an accuracy of $2 \cdot 10^{-9}$) [3] was constructed in the wave range of 4mm. Thus, the transition frequency of $I_{01} - O_{00}$ of the formaldehyde molecule H_2CO proved to be equal to

$$\nu(I_{01} - O_{00}) = 72\ 838\ 338\ 860\ \text{Hz} [3].$$

A more simple but considerable less precise

($\sim 10^{-4}$) is the method of the line frequency measurements by the comparison with the reference spectrum simultaneously recorded over the other canal of the spectroscope with the acoustic detector. When the distance between the reference and the measured line is less than 0.5GHz the precision of measurements may be raised up to $\sim 1 \cdot 10^{-6}$ using the method of frequency modulation of the BWO [4] .

A large volume of information obtained by the described method of the submillimeter radio spectroscopy with the acoustic detector demand the development of methods of the computer spectra processing. The program of the computer calculation both of the direct and the inverse problems of the radio spectroscopy is developing at NIRFI. Wide range and large values of λ are the specific features of this problem.

Results reported in this paper show, in our opinion, the real possibility to activate the submillimeter radio spectroscopy studies, to make up a map of submillimeter spectra, to create commercial submillimeter spectral devices and to apply in practice this part of the spectrum.

REFERENCES

1. A.F.Krupnov, Izv.VUZov, Radiofizika, 13, 961, 1970.
2. A.F.Krupnov, V.A.Skvortsov, L.A.Sinegubko, Izv.VUZov Radiofizika, 11, 1186, 1968.
3. A.F.Krupnov, M.Ya.Ovcharov, V.A.Skvortsov, A.A.Ul'yannov, A.P.Sheronov, Izv.VUZov, Radiofizika, 12, 224, 1969.
4. A.F.Krupnov, L.I.Gershtein, V.G.Shustrov, V.V.Polyakov, Izv.VUZov, Radiofizika, 12, 1584, 1969.
5. A.F.Krupnov, L.I.Gershtein, V.G.Shustrov, V.V.Polyakov. Optika i Spektroskopiya, 28, 480, 1970.
6. A.F.Krupnov, L.I.Gershtein, Pribory i Tekhnika Eksperimenta, N5 130, 1970.
7. A.F.Krupnov, L.I.Gershtein, V.G.Shustrov, S.P.Belov, Izv.VUZov, Radiofizika, 13, 1403, 1970;
A.F.Krupnov, L.I.Gershtein, S.P.Belov, A.V.Burenin. XVII Conference on Spectroscopy (Abstracts of reports) Minsk, 5-9 July, 1971.
8. A.F.Krupnov, L.I.Gershtein, Pribory i Tekhnika i Eksperimenta, N6, 143, 1970.
9. A.F.Krupnov, L.I.Gershtein, V.G.Shustrov, Optika i Spektroskopiya, 30, 790, 1971.

10. Yu.A.Dryagin, A.F.Krupnov, L.M.Kukin, V.A.Skvortsov,
Pribory i Tekhnika Eksperimenta, NI, 95, 1969.
11. I. Tyndall. Nature, 23, 374, 1880-1881.
W.G.Röntgen, Wied. Ann. 12, 15, 1881.
12. M.L.Veingerov, DAN USSR, 19, 687, 1938;
Automatic Gas Analysers, TzINTI EP i P, M. 1969.
13. W.D.Hershberger, E.T.Bush, G.W.Leck, RCA, Rev, 7, 422, 1946
14. M.B.Golant, R.L.Vilenkin, E.A.Zyulina, Z.F.Kaplun,
A.A.Negirev, V.A.Parilov, T.B.Rebrova, V.S.Savel'eb,
Pribory i Tekhnika Eksperimenta, N4, 136, 1965;
M.B.Golant, Z.T.Alekseenko, Z.S.Korotkova, L.A.Lun-
kina, A.A.Negirev, O.P.Petrova, T.B.Rebrova, V.S.Sa-
vel'eva, Pribory i Tekhnika Eksperimenta, N3, 231,
1969.
15. W.Gordy, R.L.Cook, Microwave Molecular Spectra,
Interscience, Wiley, 1970.
16. Ch. Tomes, A.Shawlov, Radiospektroskopiya, IL, M.
1959.

Table I

Allowed (non-saturating) power flow density
 (watts/cm²) for different values of dipole moment
 and line breadth

Line breadth MHz	dipole moment (debye units)		
	1	10 ⁻¹	10 ⁻² or Bohr magne- ton
1	10 ⁻²	1	10 ²
10	1	10 ²	10 ⁴
10 ²	10 ²	10 ⁴	10 ⁶
10 ³	10 ⁴	10 ⁶	10 ⁸

Part of the spectrum N_2O

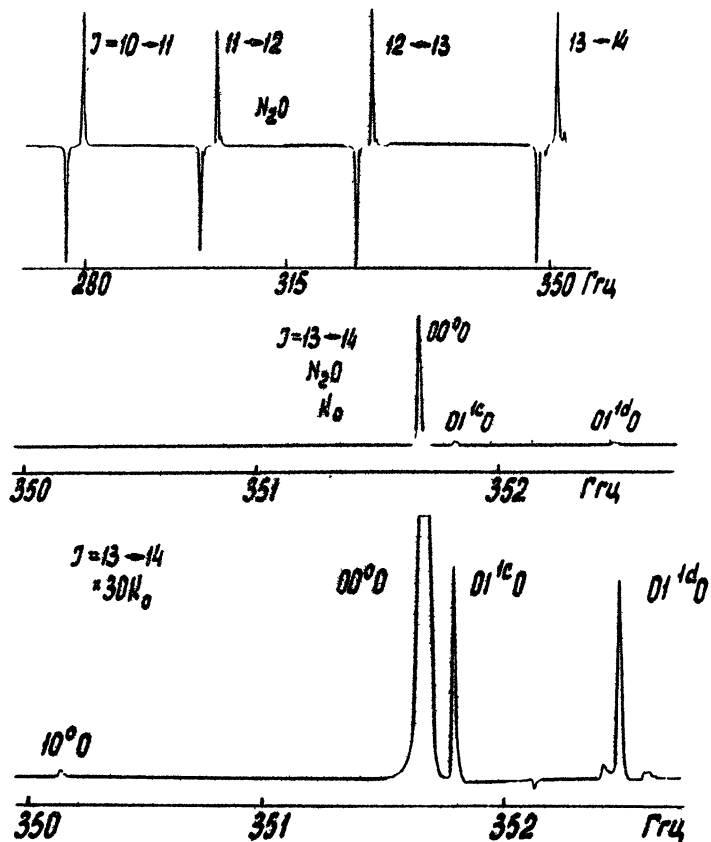

Fig I.

A part of submillimeter spectrum of N_2O . The records made with the amplification coefficients K and the resolving power increasing. Frequencies in GHz.

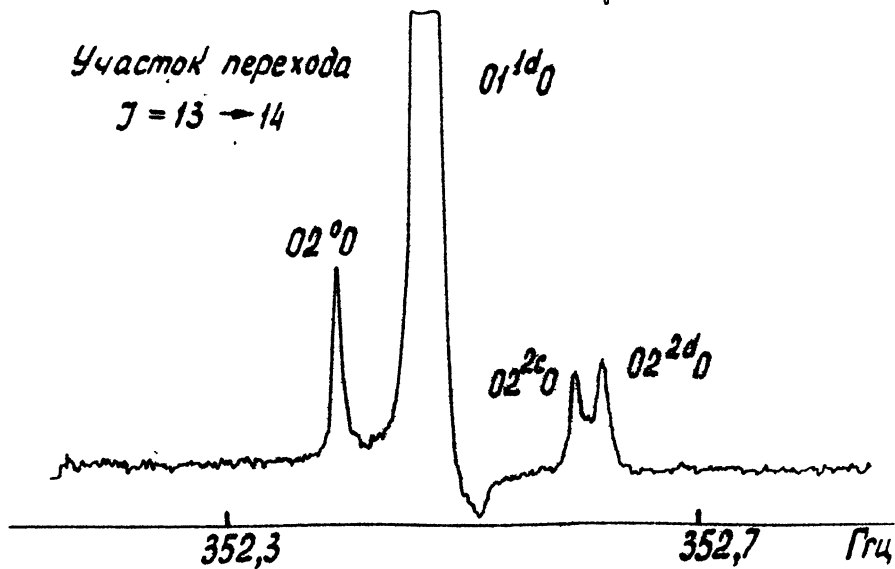
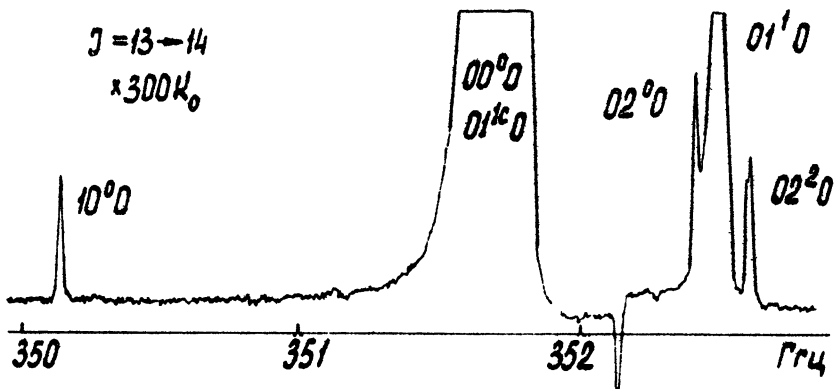

Fig.I. (continued)

A part of submillimeter spectrum of N_2O

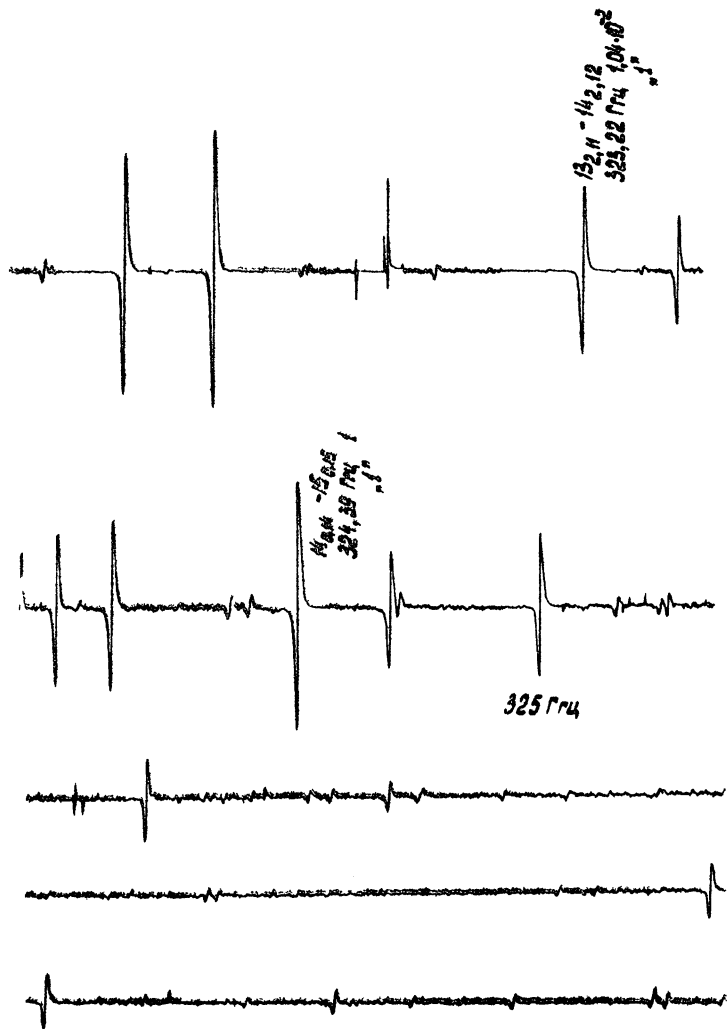

Fig.2.

A part of submillimeter spectrum of HCOOH. The record made with two amplification values differing by 10 times. At the larger amplification noise is seen. Frequencies in GHz.

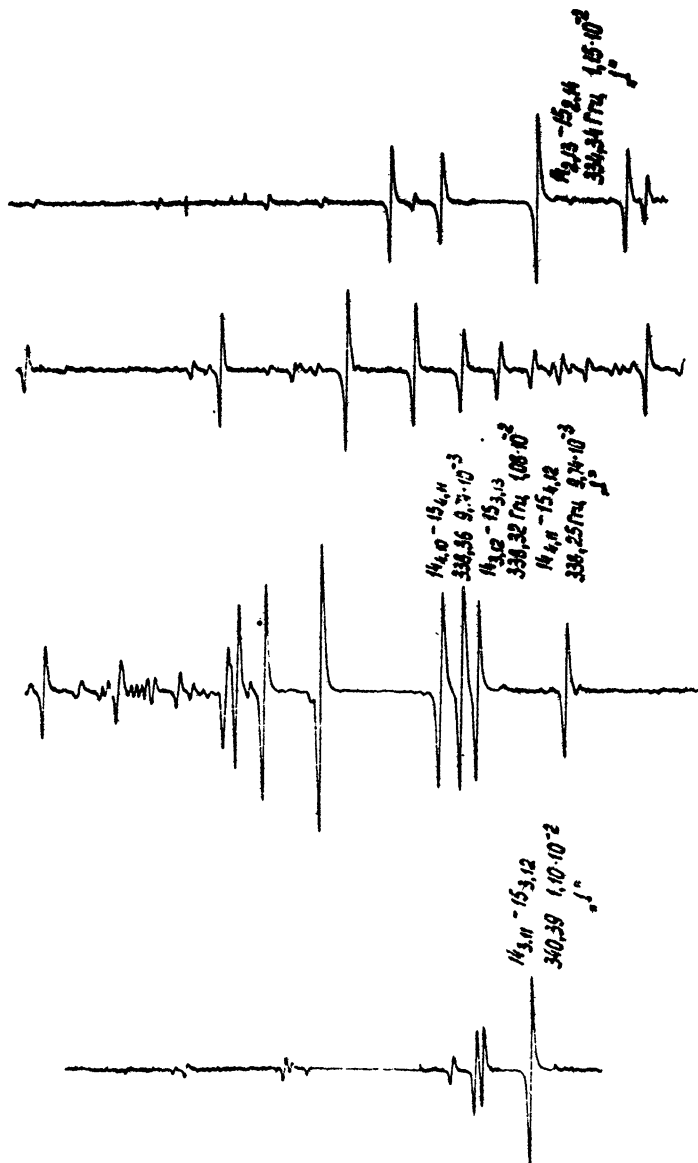

Fig.2. (continued).

A part of submillimeter spectrum of HCOOH.

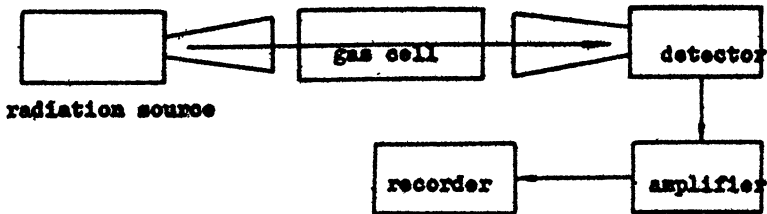

Fig. 3 Scheme of common spectrometer with microwave detector

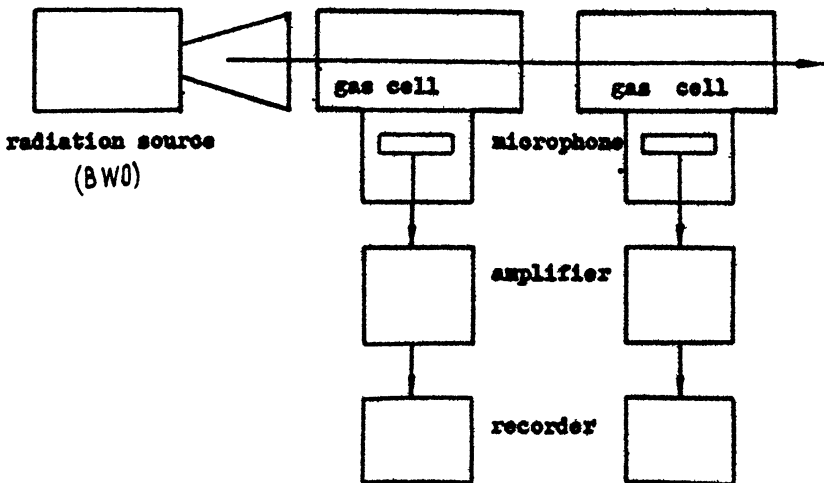

Fig. 4 Scheme of spectrometer with acoustic detector (two-channel).

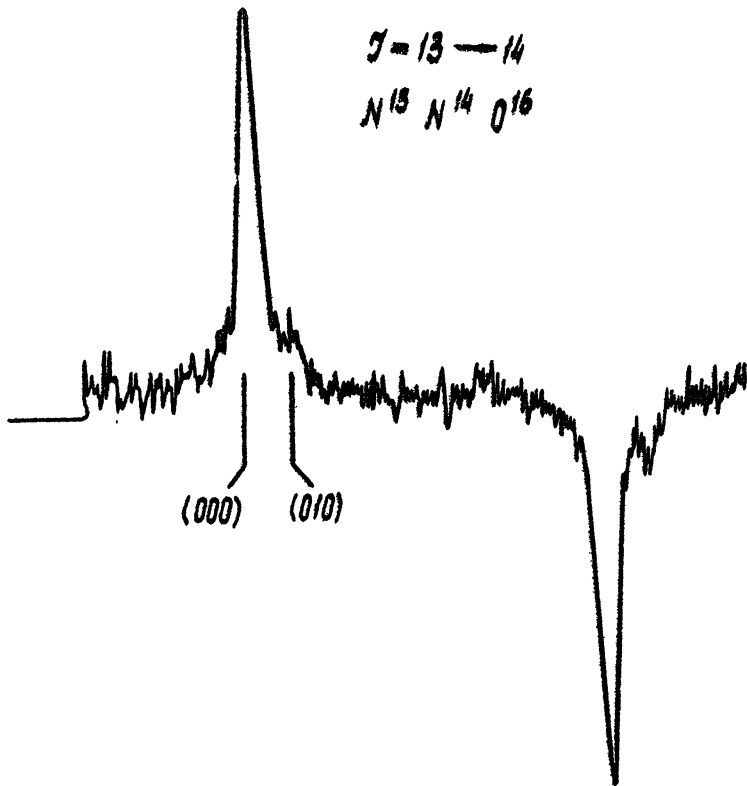

Fig.5.

A record of rotational transition $J=13 - 14$ isotopic specie of nitrous oxide $N^{15} N^{14} O^{16}$ in natural abundance. At right is vibrational satellite.

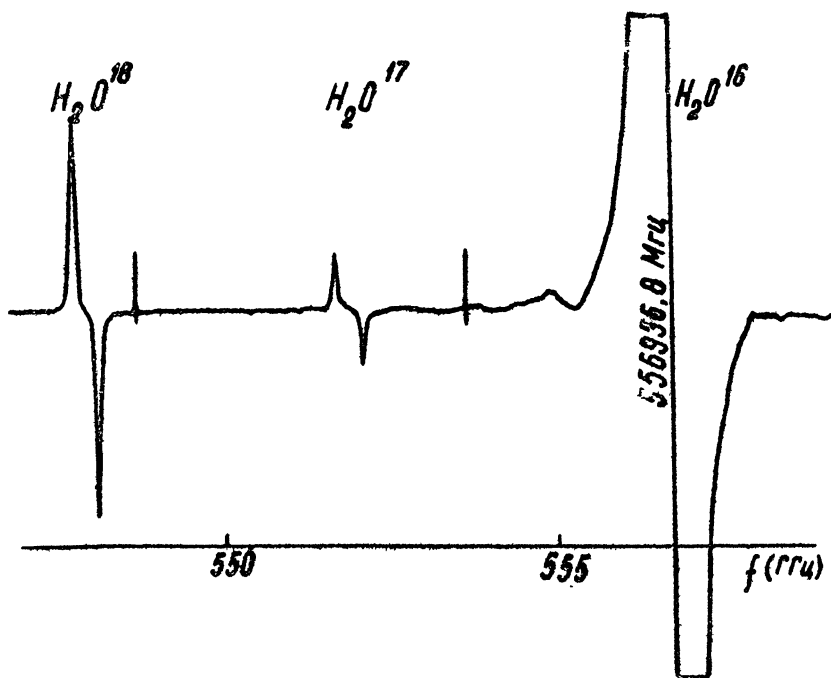

Fig. 6.

$I_{101} - I_{10}$ transition lines of water H_2O^{18} , H_2O^{17} and H_2O^{16} in natural abundances (respectively, $2 \cdot 10^{-3}$, $4 \cdot 10^{-4}$ and 0.9976). Wavelength near 0.54 mm.

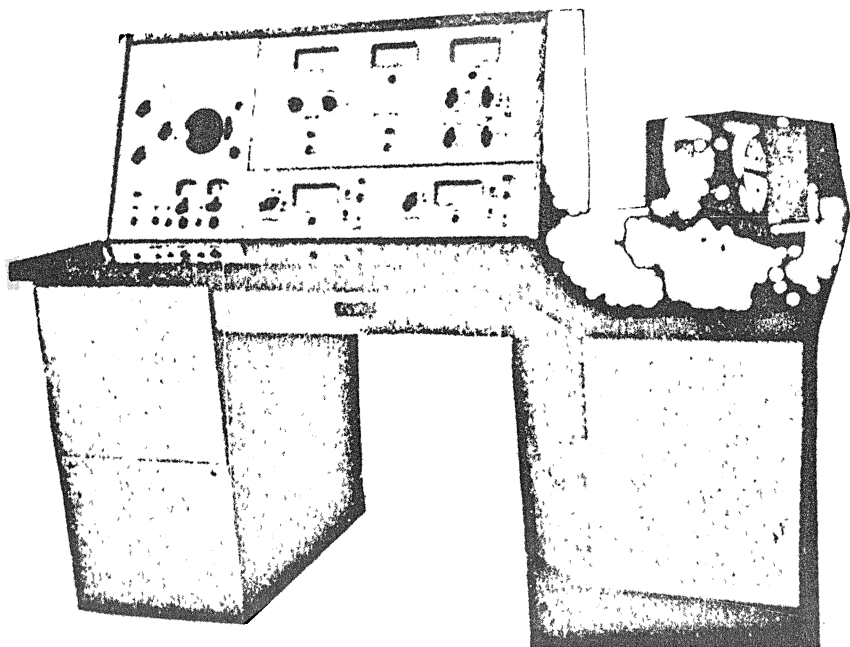

Fig. 7

Submillimeter wave spectrometer with backward-wave oscillators and acoustic detector.

Bandwidth	$2_{-0,5}^{\text{mm}}$
Sensitivity	$2 \cdot 10^{-7} \text{ cm}^{-1}$
Receiving power	$3 \cdot 10^{-5}$
Automatic recording of two spectra	

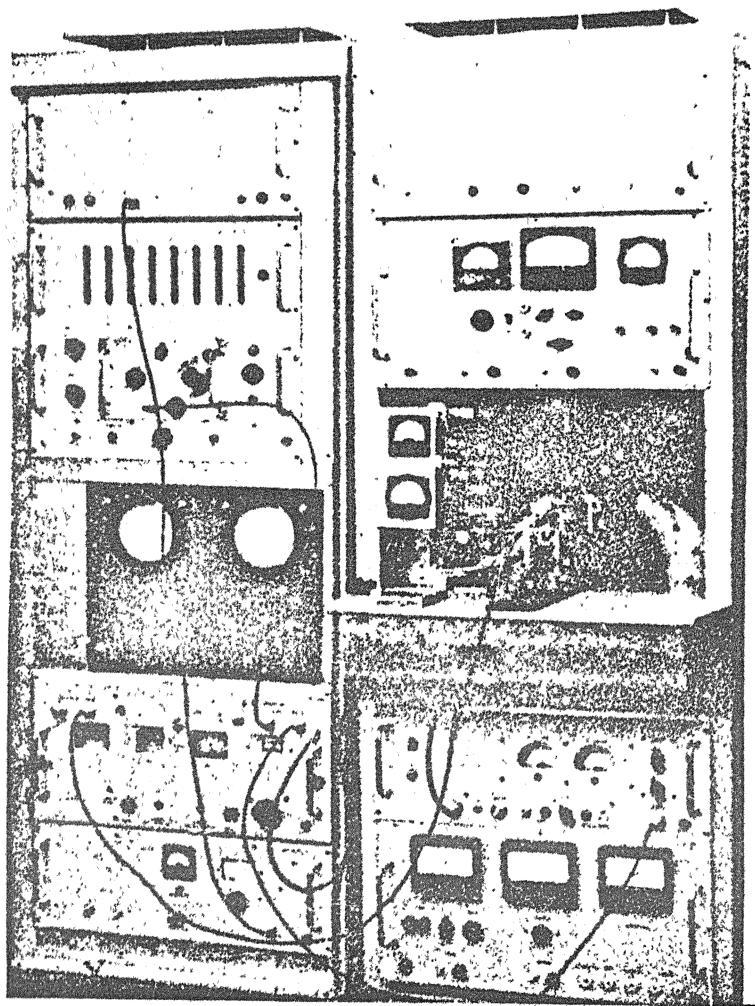

Fig.8.

Submillimeter wave spectrometer with system of frequency measurements with quartz accuracy ($2 \cdot 10^{-6}$). Bandwidth 1.2 ± 0.5 mm.